

MIKROBRYTER SERIE V3

83161102

Mikrobryter V3, vekslende kontakt høyeffekt W2
tilkobling

- Last 0,1-16 A/250 V AC
- Driftstemperatur -20 til +125 °C
- Manøverarm kan monteres i fire ulike posisjoner



PRODUKTBESKRIVELSE

Mikrobryter serien V3 har en vekslende kontakt og mulighet for last på 0,1-16A/250V AC. Manøverarm kan monteres i fire ulike posisjoner.

TEKNISKE DATA

Allowable Operating Force Max	20 N
Differensialvandring maks.	1,1 mm
Hvileposisjon maks.	16,1 mm
Hysterese maks.	0,35 mm
IP-klasse	IP40
Kontaktgap	0,4 mm
Kontakttype	Vekslende kontakt
Manøverkraft maks.	3 N
Merkestrøm ved 250 V AC	16 A
Operating Power Total Max	4,5 N
Returbevegelseskraft min.	1 N
Temperaturområde fra	-60 °C
Temperaturområde til	125 °C
Termisk merkestrøm ved 250 V AC	20 A
Tilkobling	W2
Tilslagspunkt	14,7±0,4 mm

W2 solder

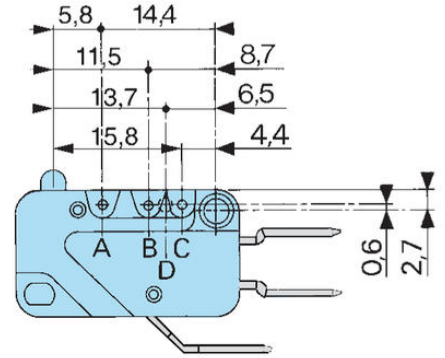
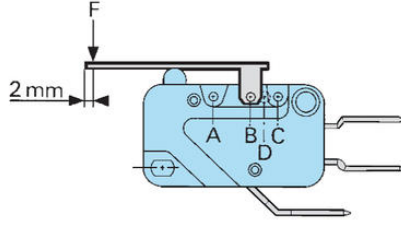
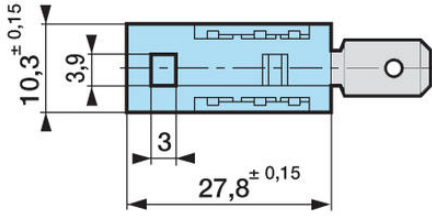
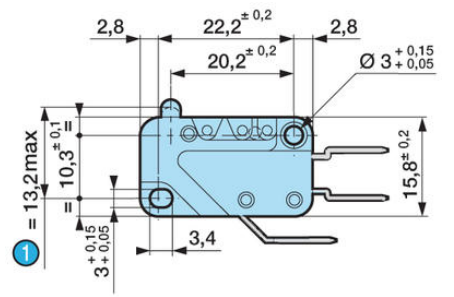
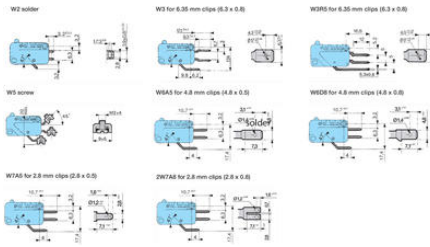
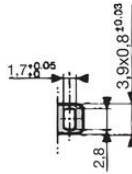
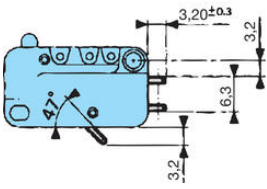

161 F

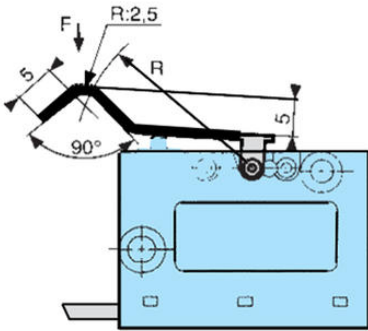

161 G

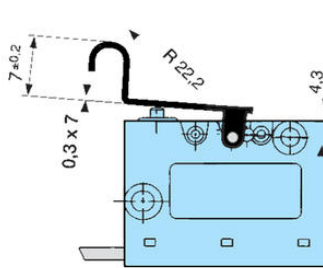

161 A

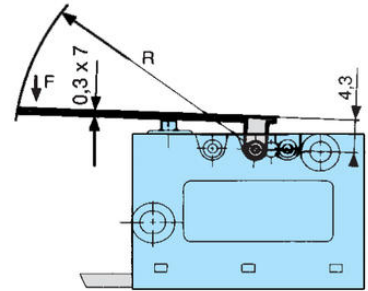

161 E

