

DVA VIBRASJONSDEMPERE

411101

Vibrasjonsdempere DVA.1-8-8-M3-6-55

- Naturgummi NR
- Forsinket Stål / Rustfritt stål
- Demper vibrasjoner, støt, lyd



PRODUKTBESKRIVELSE

Materiale

Bunnplate: DVA-forsinket stål

Gummidempere: Naturgummi NR, hardhet 55 ± 5 Shore A, sort farge.

Standard versjon:

DVA.2: gjenget stift og gjennomføring i polert galvanisert stål, ikke-gjennomgående hull.

DVA.7: gjennomføring i polert galvanisert stål, ikke-gjennomgående hull.

Egenskaper og bruk:

DVA vibrasjonsdempende er designet for å dempe lyder og vibrasjonsstøt, som kan forårsake feil og forkorting av maskinens levetid og/eller tilstøtende utstyr.

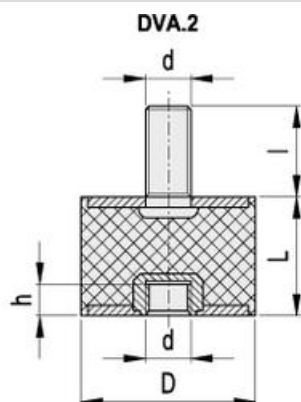

DVA.2 - 8 - 8 - M3 - 6 - 55
 D L d l Shore A

Artikkel	Beskrivelse	D	L	d	l	h	Hardhet
417201	DVA.2-50-40-M10-28-70	50	40	M10	28	10	55

DVA.7

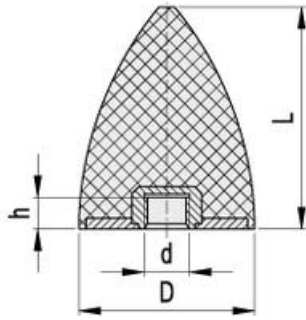

DVA.7 - 20 - 24 - M6 - 55

D L d Shore A

Artikkel	Beskrivelse	D	L	d	h	Hardhet
413631	DVA.7-35-40-M8-55	35	40	M8	8	55

DVA.1

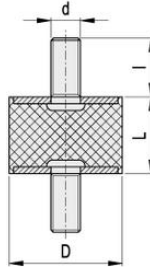

DVA.1 - 8 - 8 - M3 - 6 - 55

D L d Shore A

DVA.2

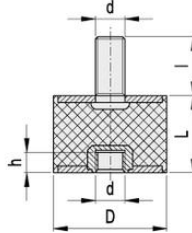

DVA.2 - 8 - 8 - M3 - 6 - 55

D L d Shore A

DVA.3

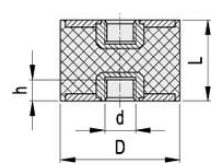

DVA.3 - 8 - 8 - M3 - 55

D L d Shore A

DVA.4

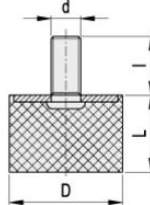

DVA.4 - 8 - 8 - M3 - 6 - 55

D L d Shore A

DVA.5

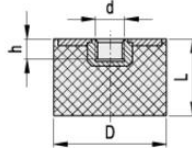

DVA.5 - 10 - 10 - M4 - 55

D L d Shore A

DVA.6

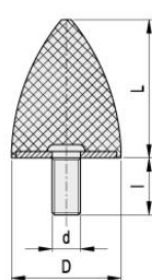

DVA.6 - 20 - 24 - M6 - 18 - 55

D L d Shore A

DVA.7

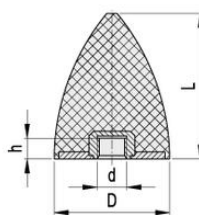

DVA.7 - 20 - 24 - M6 - 55

D L d Shore A